

TECE
close to you

IT'S NEVER TOO LATE FOR MORE FRESHNESS

Design covers for easy retrofitting of
a TECE shower toilet for cold water
connection



Just like a fresh shower!

You can't beat the feeling of being freshly showered. With our TECEone shower toilet, you can experience this freshness every time you go to the toilet. With the new retrofit design cover you can now easily replace your old toilet with the cold water shower toilet TECEone. Almost without dirt and without having to drill or chisel.

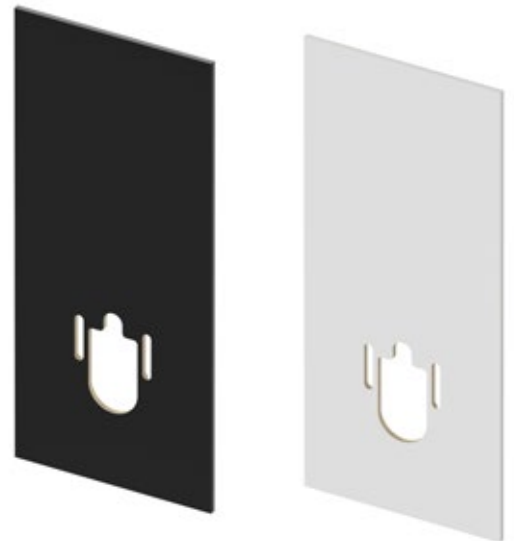

Not only a visual eye-catcher

The new retrofit design cover is impressive both visually and functionally: its velvet-matt anti-fingerprint surface made of abrasion- and scratch-resistant high-pressure laminate is not only elegant, it is also extremely easy to clean. The sandwich cover is moisture-resistant and offers various guide grooves on the back for the water connection of a TECE shower toilet. This means that any technology is hidden behind the elegant surface.

See here how easy it can be to retrofit a TECEone cold water shower toilet.

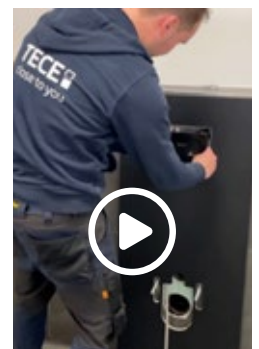

Retrofitted in no time at all

When we developed the retrofit design cover, the focus was not only on the appearance but also on easy assembly. For example, the pressure-resistant sandwich cover weighs only approx. 6.7 kg, making it easy to handle. The cut-out for the flush plate can easily be made with a jigsaw. With a width of 12 mm, the guide grooves for the reinforced hoses are optimally adapted to the TECE fine installation set for shower toilets.

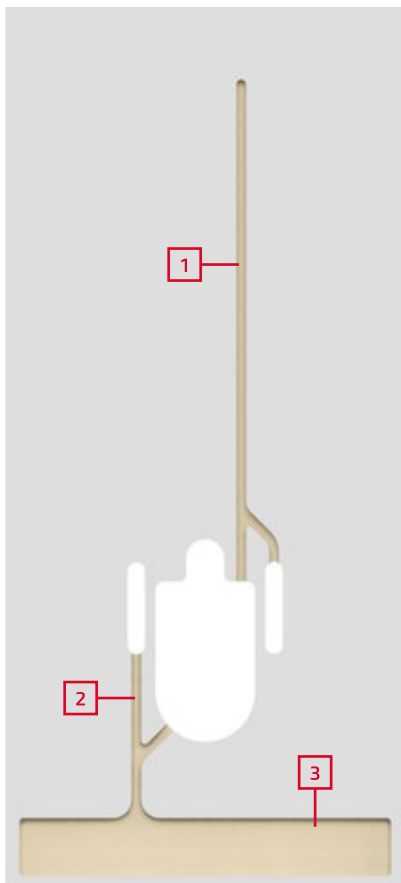





- 1 Hose guide from shower toilet to cistern
- 2 Additional guide grooves for different connection points for water or electricity
- 3 Recess for optional connections such as power supply or supply line via the skirting board



- Simple retrofitting of a TECE shower toilet with cold water connection
- High-quality and easy-care design surface
- Fast and simple assembly
- Moisture-proof, robust and lightweight material

Shower toilet retrofit in four easy steps:
make a cut-out for the flush plate, connect the water, fix the plate and install a TECE shower toilet with cold water connection. Job done.

	Description	Item no.
	<p>Universal retrofit cover for easy retrofitting of a TECEone shower toilet cold water in an existing bathroom.</p> <p>Matt white Matt black</p>	<p>9700620 9700621</p>
	<p>TECE fine installation set for shower toilet module Fine installation set for connecting a shower toilet</p> <p>Module height 1120 mm Module height 980 mm Module height 820 mm</p>	<p>9880052 9880053 9880054</p>
	<p>TECEone toilet ceramics with shower function, cold water</p>	<p>9700201</p>
	<p>TECEone - toilet seat with lid</p>	<p>9700600</p>

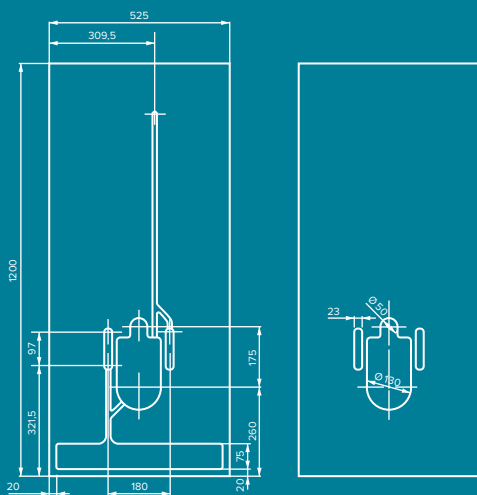

Can be combined with shower toilets from other manufacturers in principle, but must be checked in advance due to the wide range of variants.

For more information visit www.tece.com/en

TECE GmbH
T +49 25 72/9 28-999
international-business@tece.de
www.tece.com/en

In order to improve the flow of reading, no distinction is made between feminine, masculine and non-binary in gender-related expressions. However, all genders are always implied.